

SDC Series

SDC12-90 12V90Ah

SDC VRLA battery uses AGM and GEL hybrid technology, it has good deep cycle and large current discharge performance. As the economy-type solar battery, it can be widely used in renewable energy, electrical vehicle etc.



Benefits

- Deep cycle for solar application
- Good large current discharge performance
- High gas recombination efficiency
- Maximum charge efficiency
- Low self-discharge rate
- Easy installation and handling

Applications

- Electrical Vehicle
- Renewable Energy
- Universal

Drawing

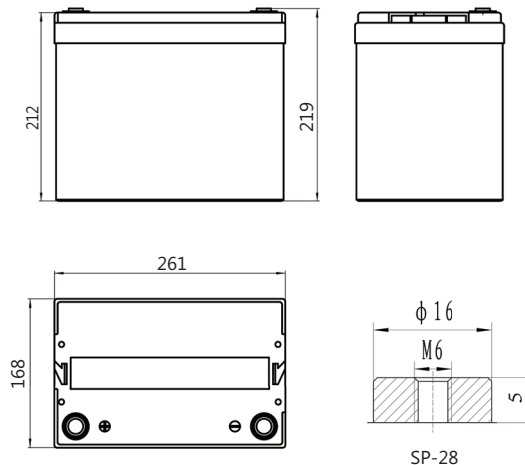

Standards

- IEC 60896-21/22
- IEC 61427
- EUROBAT guide

Specifications

Battery Model	SDC12-90			
Design Life (years, 25°C)	10			
Capacity (Ah, 25°C)	20HR (4.75A, 1.75V)	10HR (9.0A, 1.75V)	5HR (17A, 1.75V)	3HR(26.67A, 1.75V)
	95	90	85	80
Dimensions (mm)	Length	Width	Height	Total Height
	261	168	212	219
Approx. Weight (kg)	26.5			
Reference Internal Resistance (mΩ)	6.0 (fully charged @ 25°C)			
Maximum Discharge Current (A/10 Sec.)	720			
Self-Discharge (25°C)	< 3% per month			
Charge Voltage (V/cell, 25°C)	Cycle use		Float use	
	2.45 (-3.0mV/°C/cell), max charge current: 12A		2.35 (-3.0mV/°C/cell)	
Short Circuit Current (A)	1320			

Discharge Data

Constant Current Discharge Data (25°C, A)												
End Voltage (V/cell)	min				h							
	10	20	30	45	1	1.5	2	3	5	10	20	
1.60	257.9	151.8	110.2	79.44	63.88	46.25	37.04	27.31	17.35	9.25	4.814	
1.65	252.3	149.1	108.6	78.41	63.08	45.75	36.70	27.10	17.22	9.19	4.790	
1.70	245.6	146.0	106.5	76.99	62.21	45.24	36.32	26.88	17.11	9.14	4.769	
1.75	238.7	142.8	104.6	75.87	61.42	44.76	36.00	26.67	17.00	9.00	4.750	

Constant Power Discharge Data (25°C, W/cell)												
End Voltage (V/cell)	min				h							
	10	20	30	45	1	1.5	2	3	5	10	20	
1.60	453.1	273.4	202.6	148.3	120.9	88.7	71.57	53.20	34.01	18.26	9.55	
1.65	451.3	272.7	202.1	148.0	120.4	88.2	71.34	53.07	33.93	18.22	9.53	
1.70	445.6	270.2	200.2	146.8	119.8	87.9	71.14	53.01	33.90	18.20	9.53	
1.75	439.0	267.6	198.9	146.1	119.3	87.7	70.99	52.87	33.84	18.17	9.51	

Performance Curve

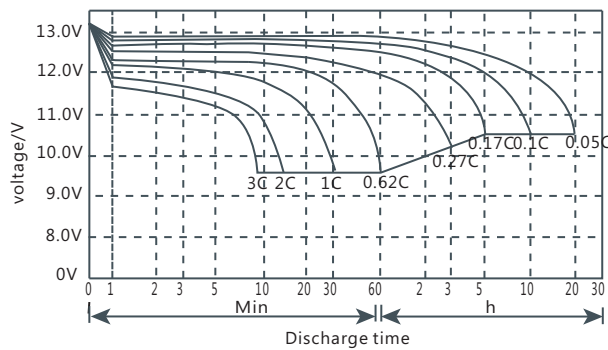

Discharge performance

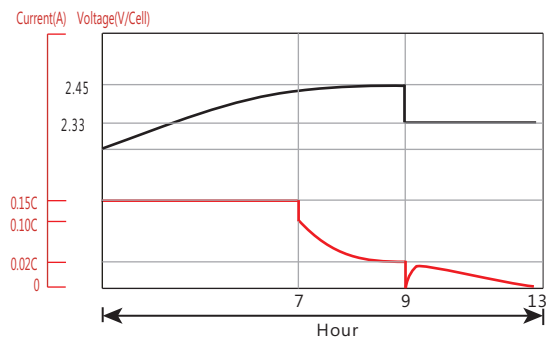

Charge performance

Sacred Sun Power Sources Co., Ltd.

No.1 Shengyang Road Qufu City, PRC
sales@sacredsun.cn

Sacred Sun Asia Pacific

No. 15, Yishun Industrial Street 1,
#01-17, WIN5, Singapore 768091
sales.asia@sacredsun.cn

Sacred Sun Europe SPRL

Schoenstraat 96-9140 Temse, Belgium
sales.eu@sacredsun.cn

Sacred Sun MEA FZE

S10122A1019 Jebel Ali, Dubai,
United Arab Emirates
sales.mea@sacredsun.cn